

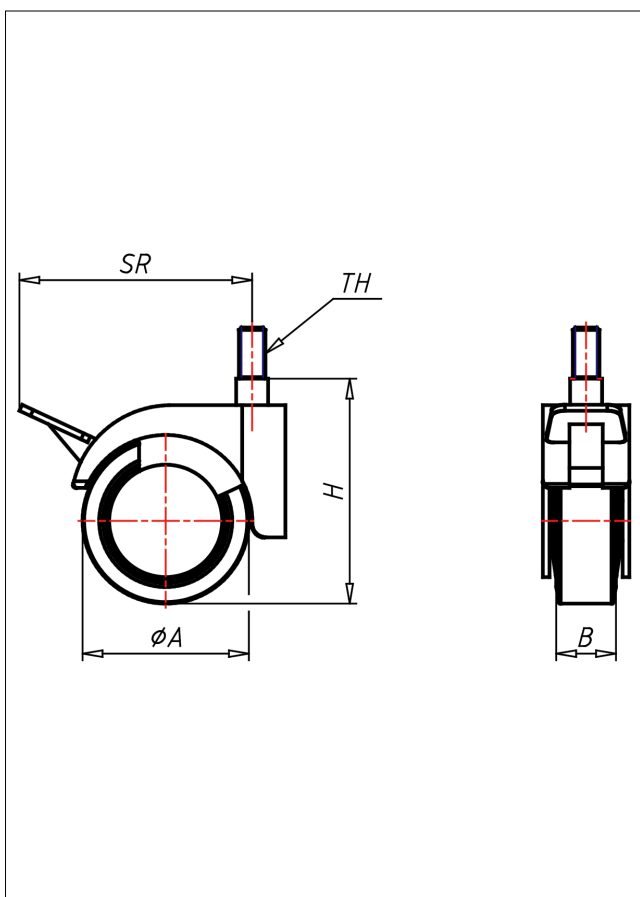

476 M8/M10/M12 DE

Lenkrolle mit Radfeststeller



475-DE



+60 °C
-20 °C

max.
40 kg



Gehäuse: Zinkdruckguss - verchromt
Schwenklager mit kombiniertem
Gleit-Kugellager
Felge Polyamid 6
elastischer PUR-Reifen - spurfrei
Radfeststeller glasfaserverstärkt
Radachse verschraubt

Technische Details

ORDERNO (Artikel-nummer)	476 M8 50 VK
WDAB (Rad-Ø A x Breite B / mm)	50x18
LC (Tragkraft / kg)	40
H (Bauhöhe H / mm)	68
TH (Gewinde / mm)	M8x15
SR (Schwenkradius / mm)	70
WB (Radlager)	Kugellager